

# WATFORD FC

80'S VICARAGE ROAD



## 3D PUZZLE ASSEMBLY INSTRUCTIONS

**A**

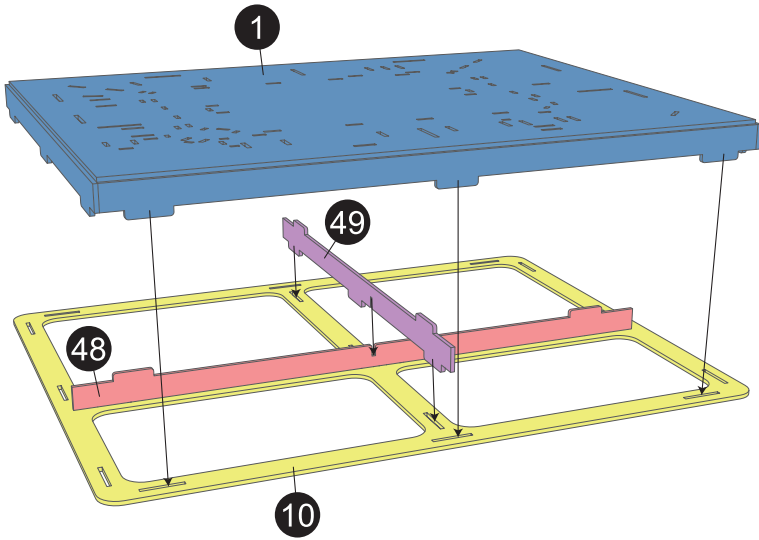

**B**

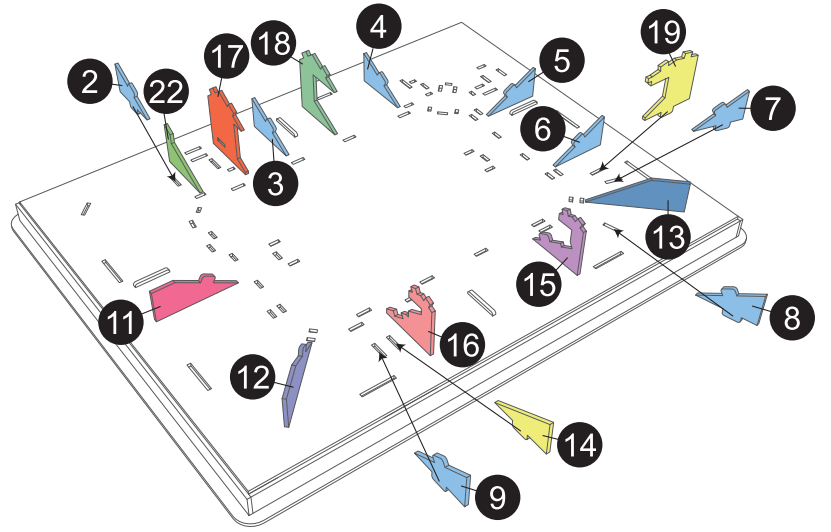

**C**

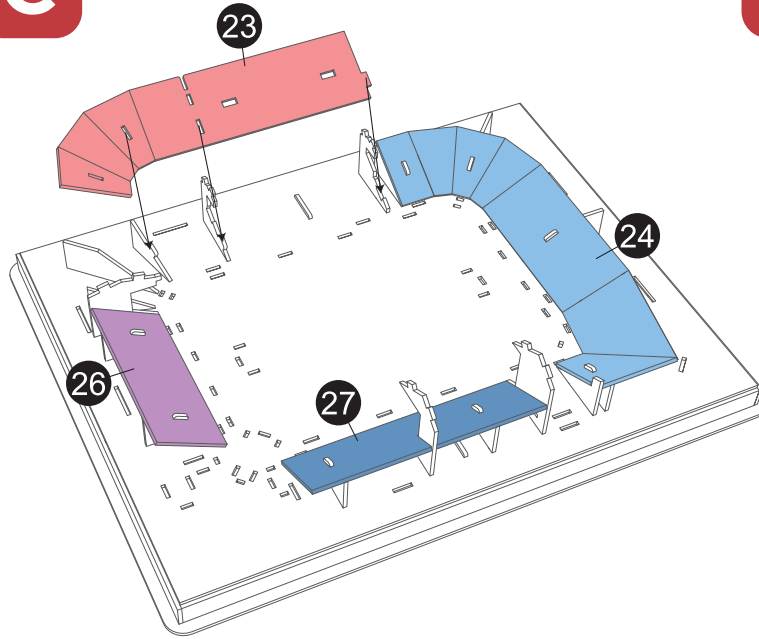

**D**

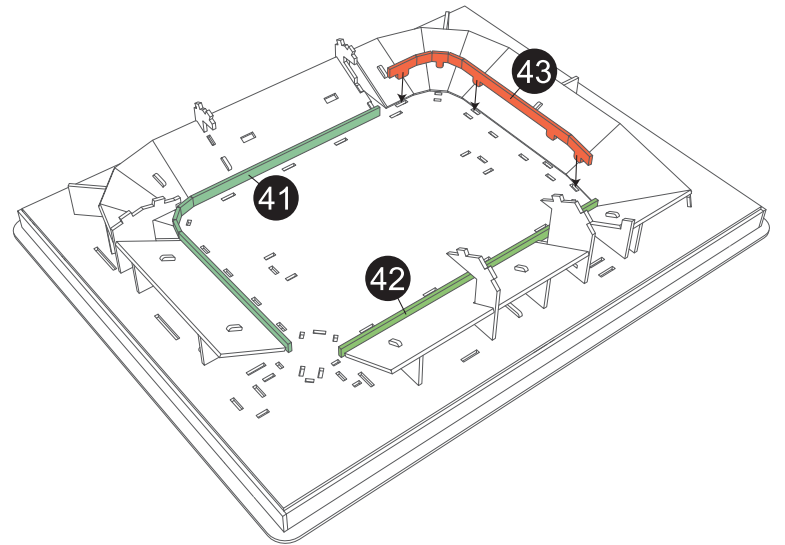

**E**

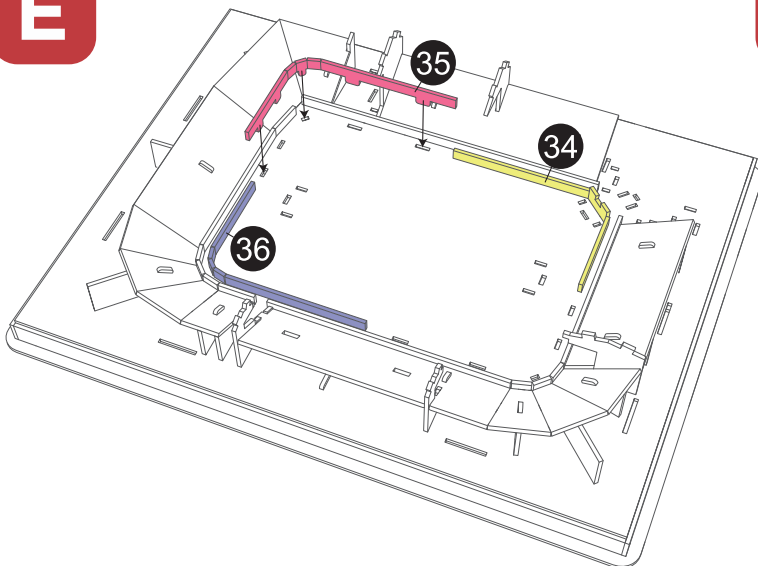

**F**

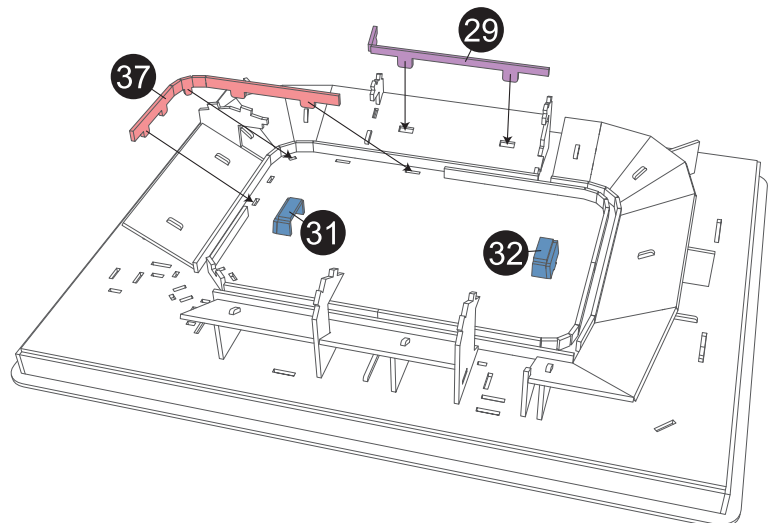

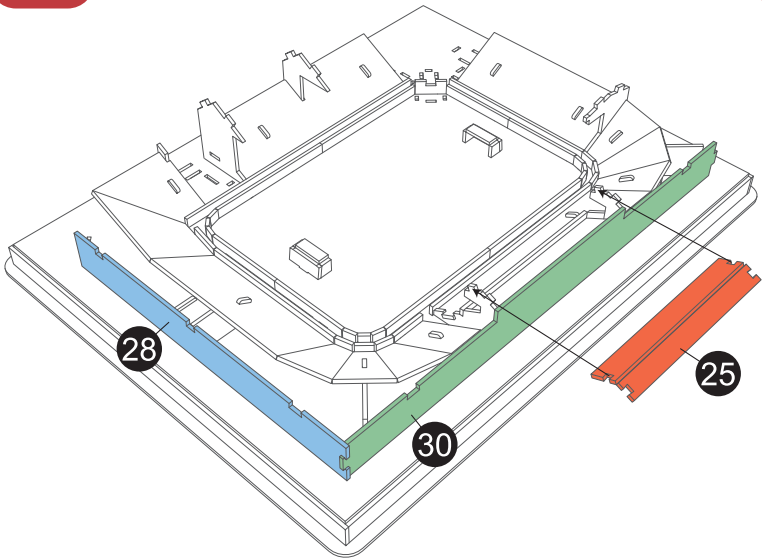
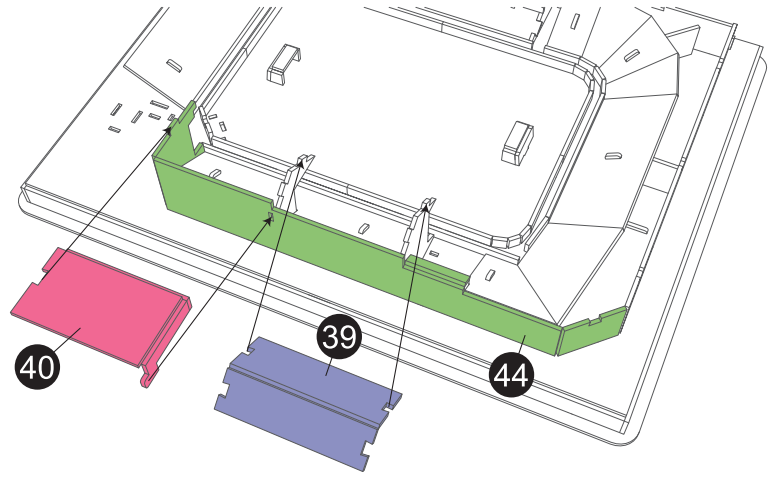
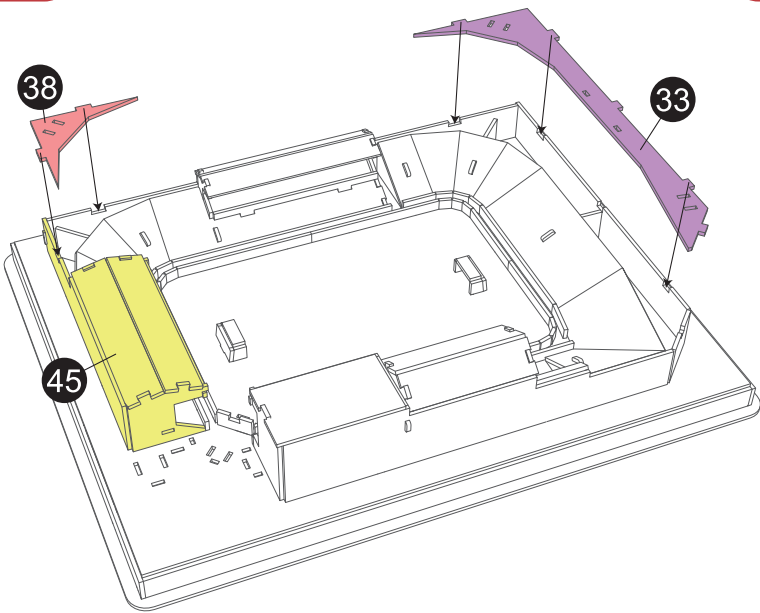
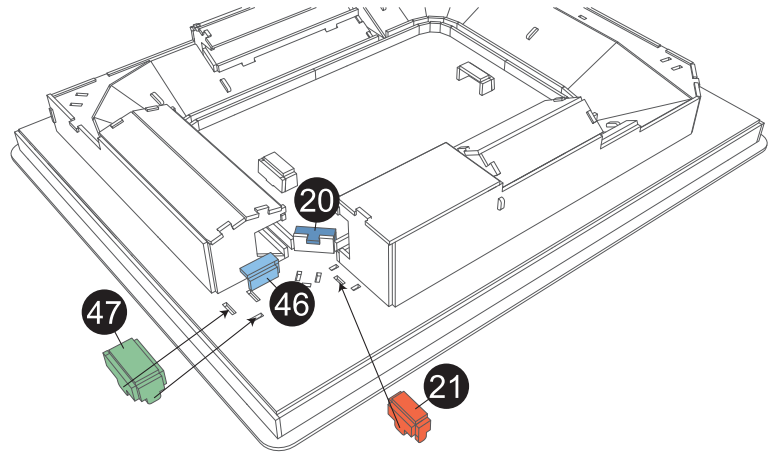
**G****H****I****J****K**