

*TIP: USE A PEN, TOOTHPICK OR PAPER CLIP TO HELP WITH INSERTING THE DIFFICULT PIECES. (ADULT SUPERVISION REQUIRED)

VILLA PARK

ASSEMBLY INSTRUCTIONS

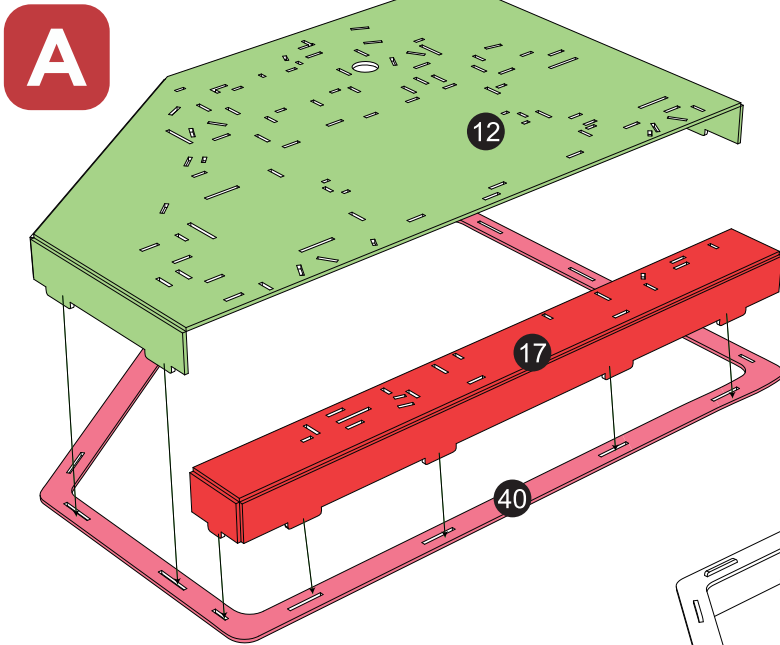

A

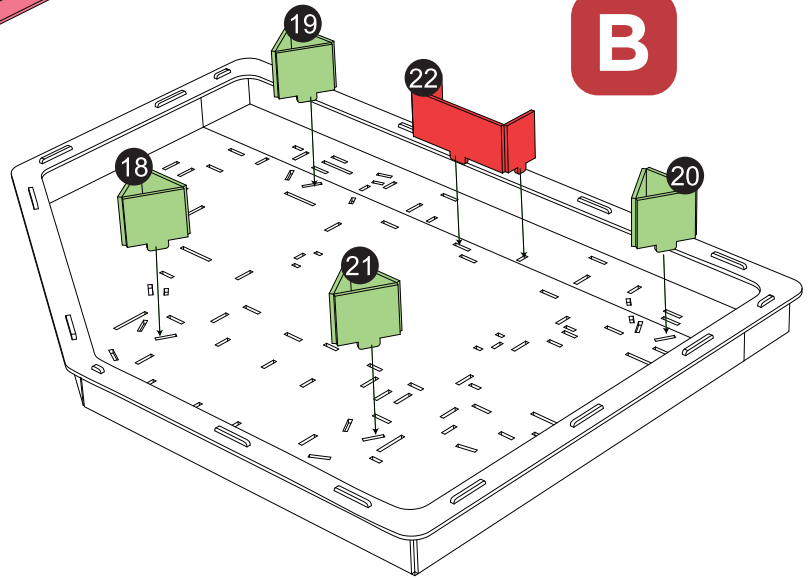

B

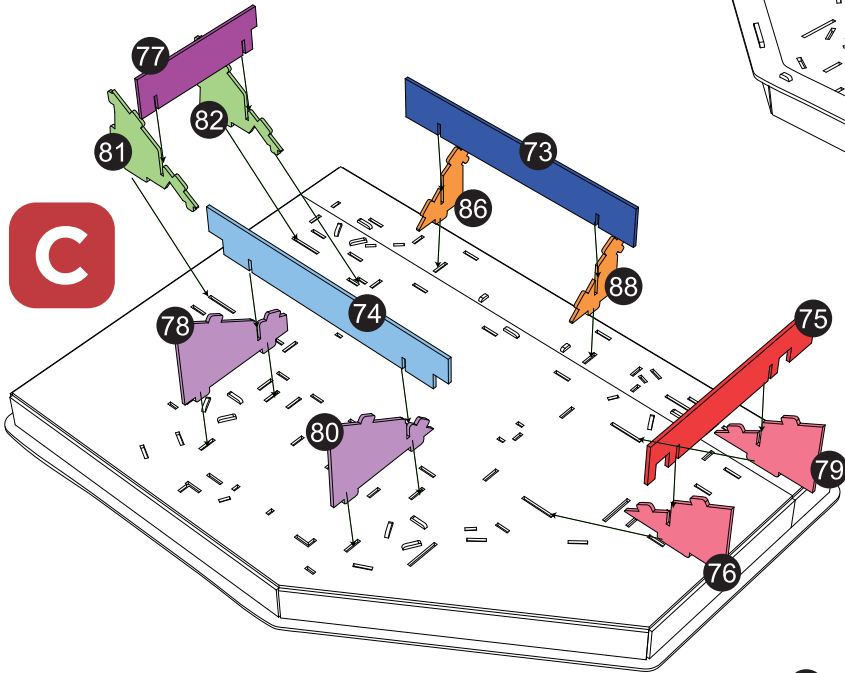

C

D

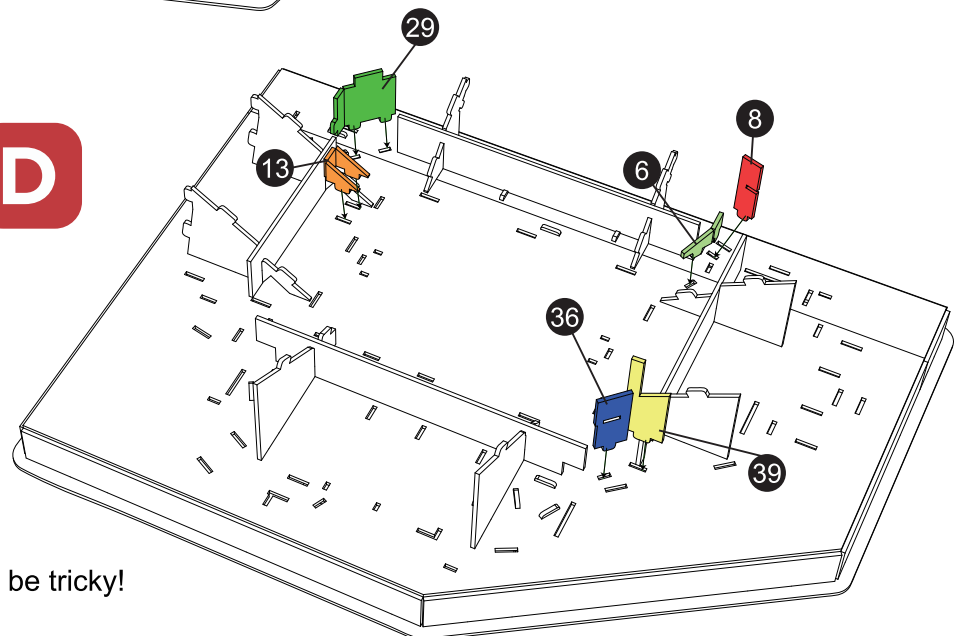

*Take your time. This step can be tricky!

E

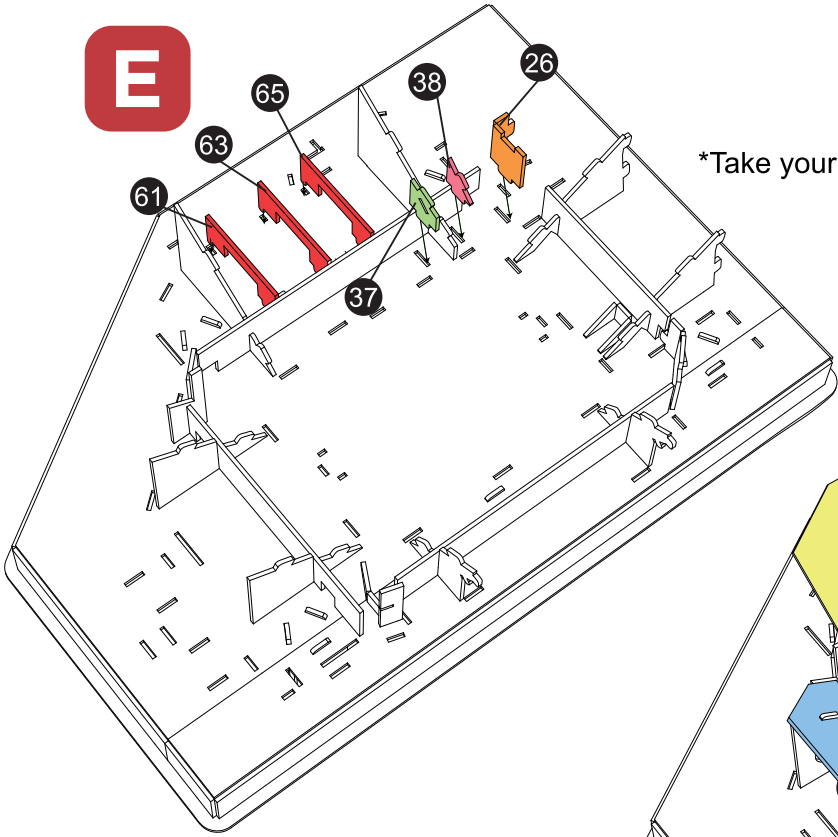

*Take your time. This step can be tricky!

F



*Take your time. This step can be tricky!

G

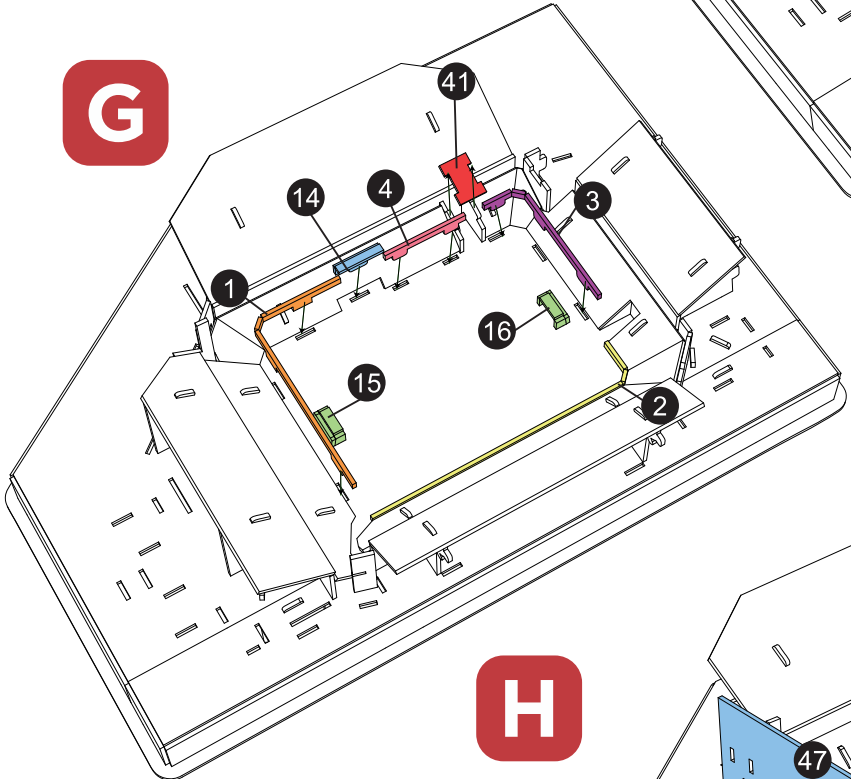

H

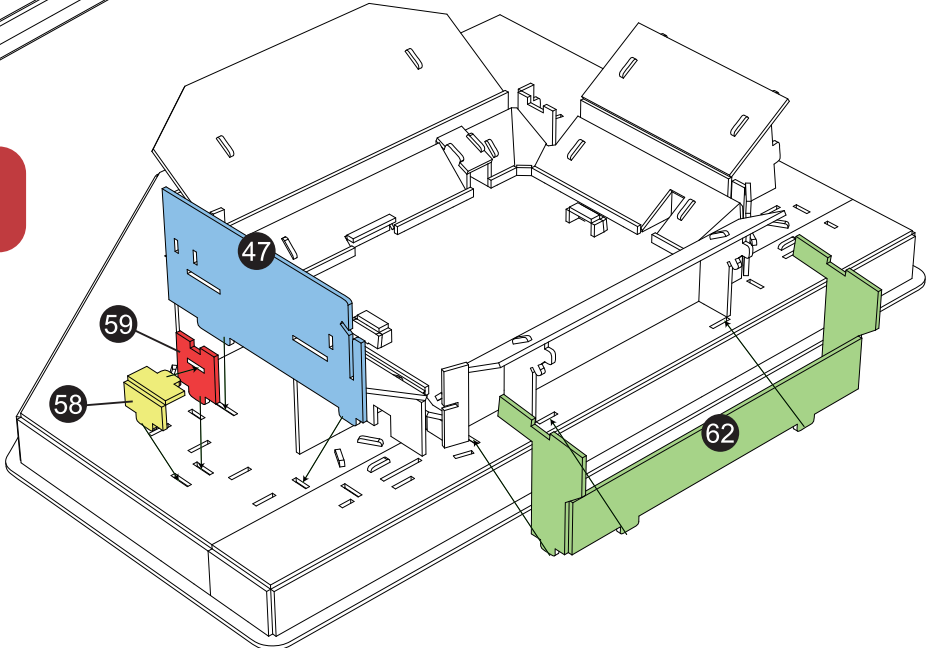

I

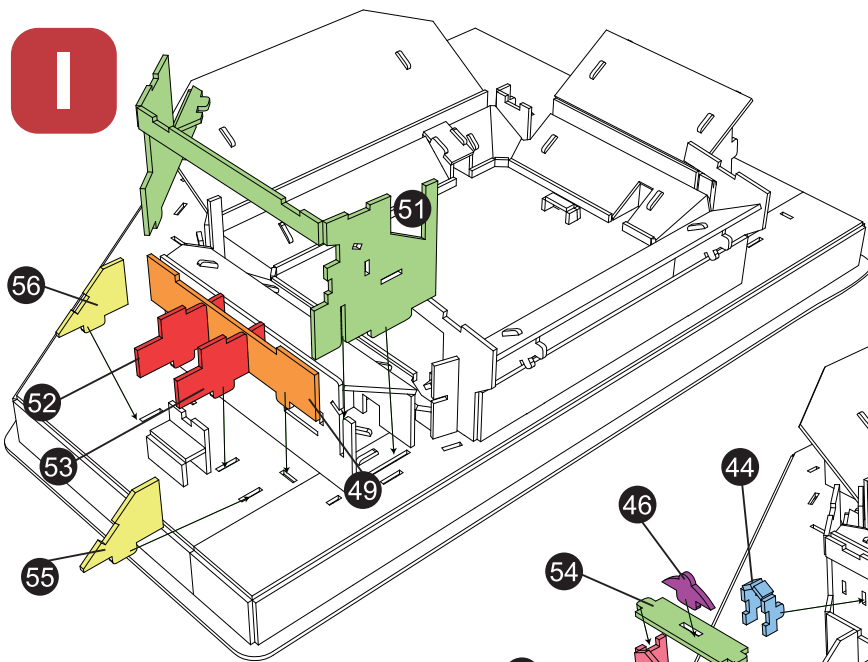

J

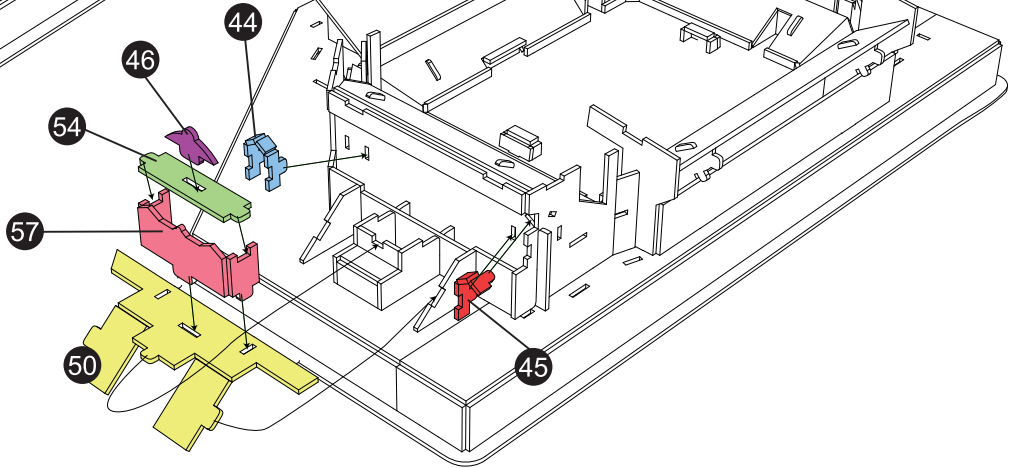

K

*Take your time. This step can be tricky!

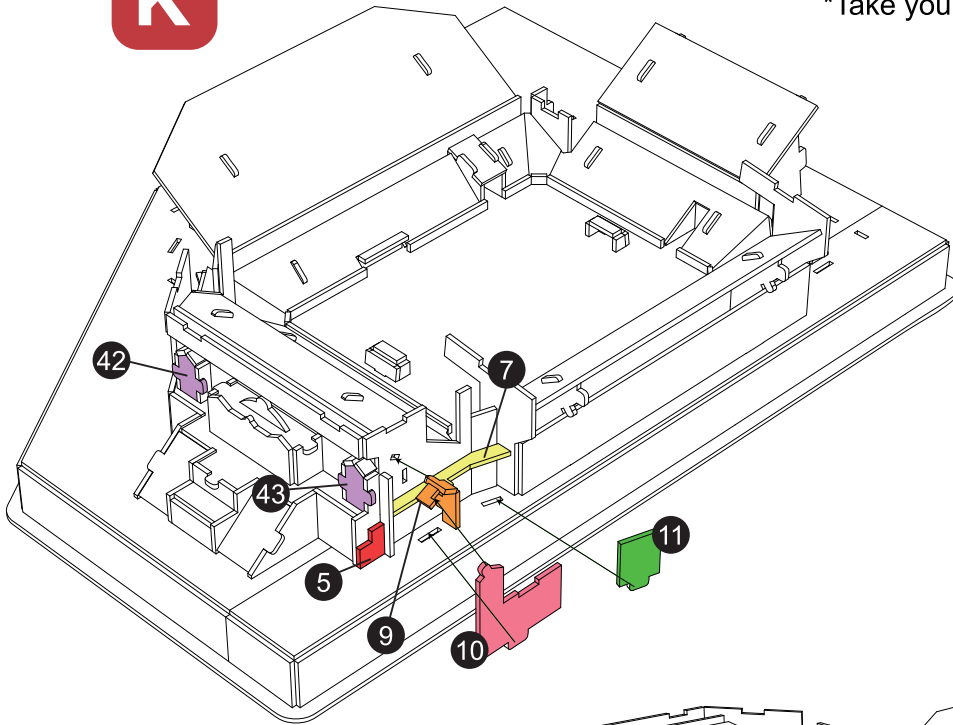

Place "28" before "33" .

L

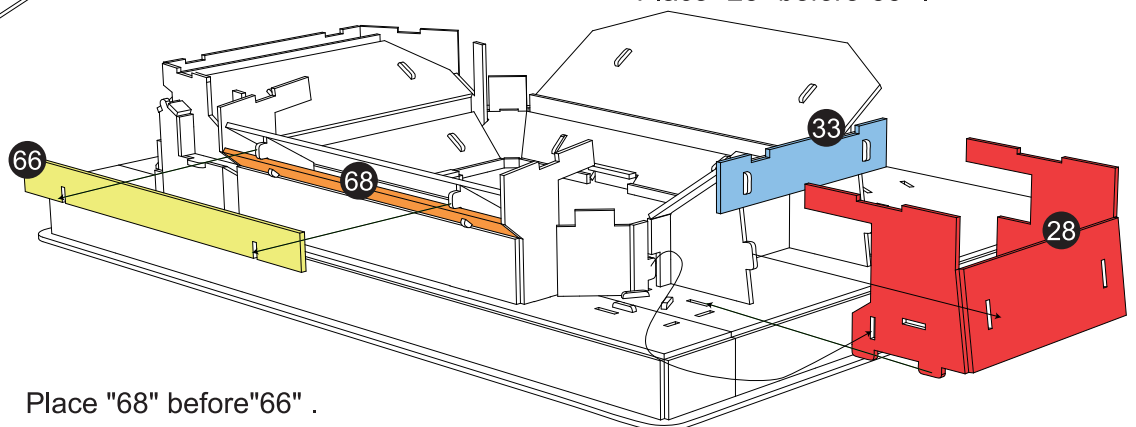

Place "68" before "66" .

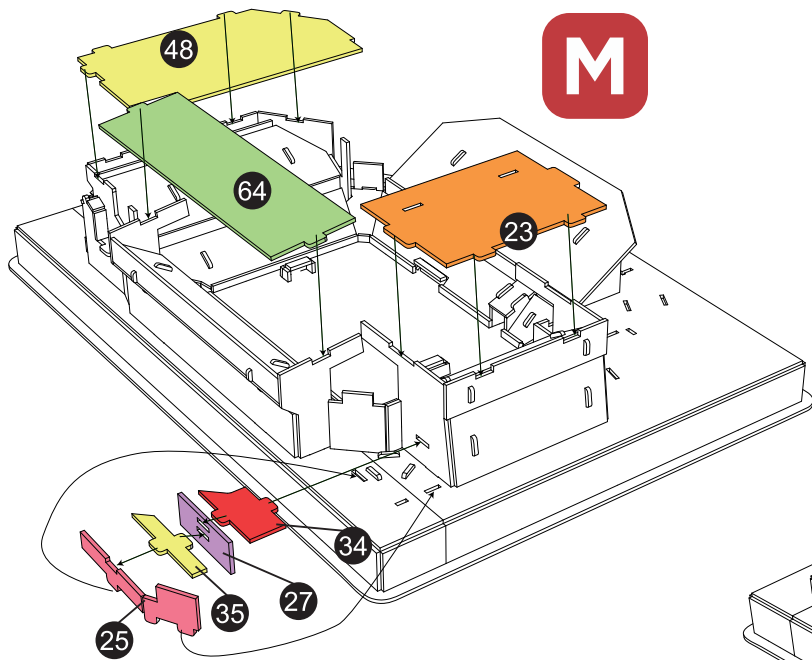

M

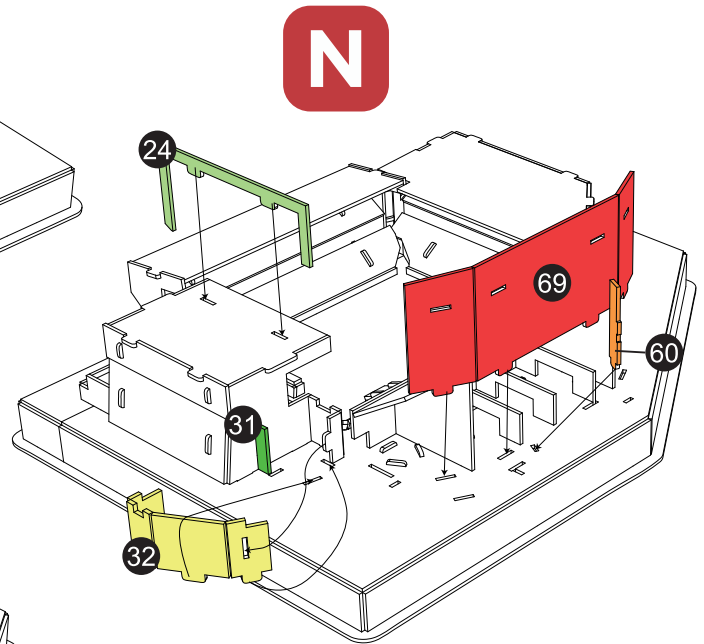

N

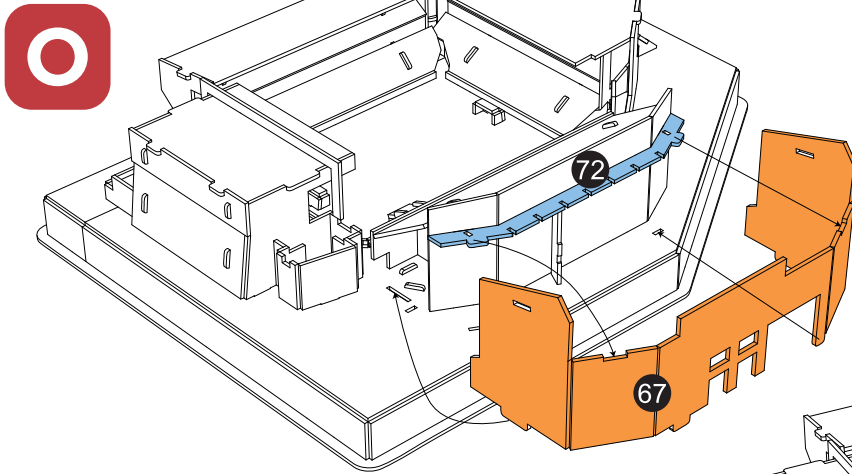

O

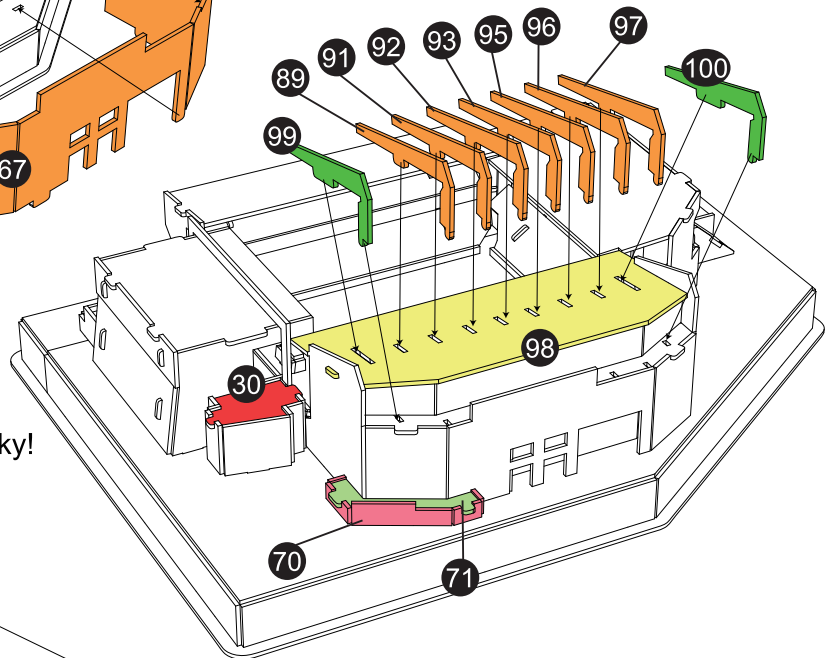

P

*Take your time. This step can be tricky!

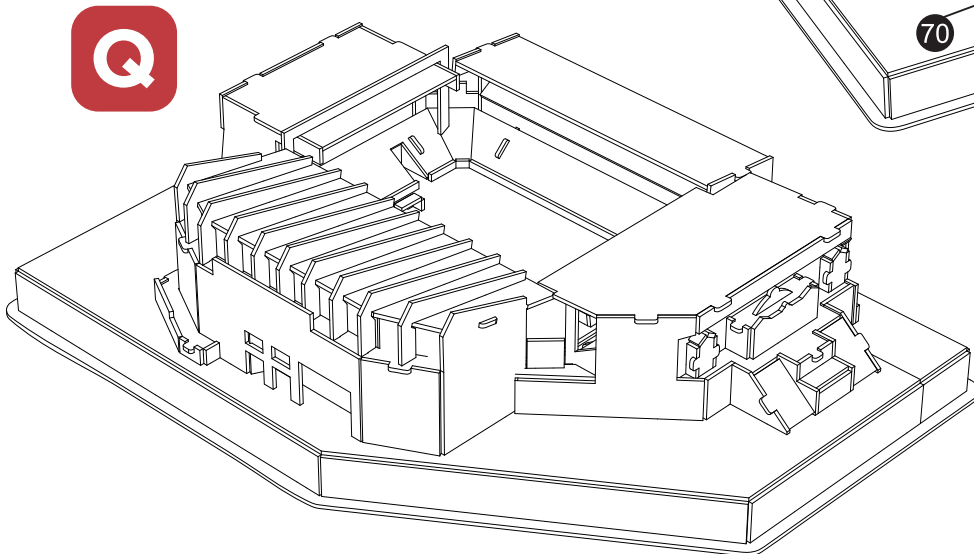

Q